

*Use your Drawing Note book*

**Complete the Exercise**

- 1. Eifel Tower, Paris**
- 2. Red Square, Moscow**
- 3. 3-D garden**
- 4. Row house in Europe**

SAMPLE

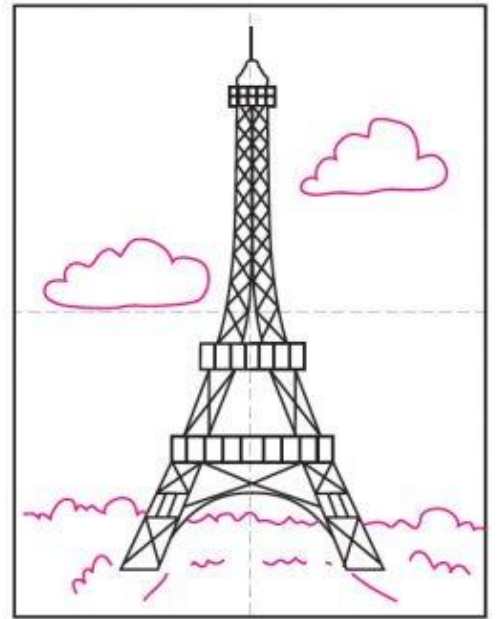
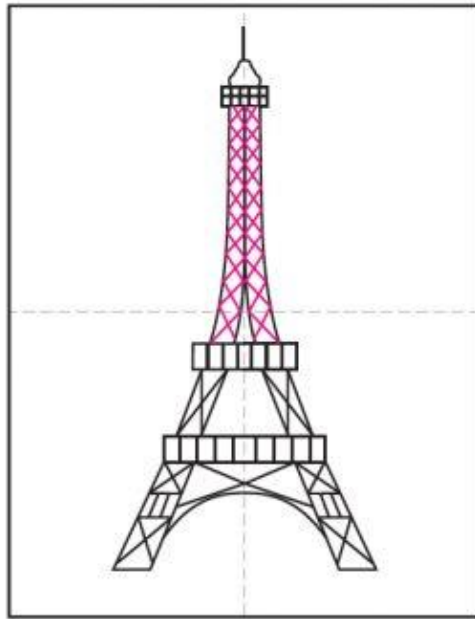
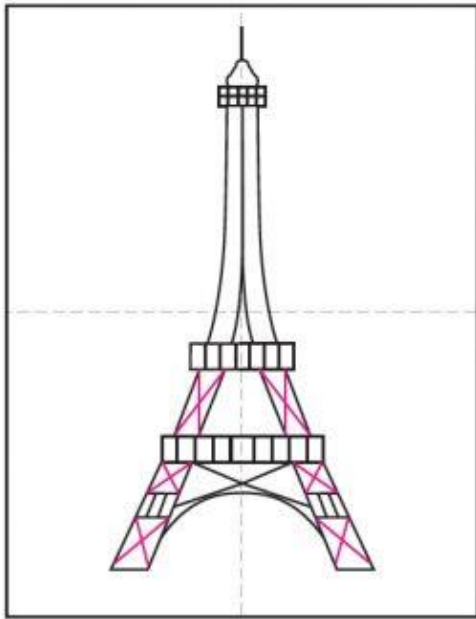
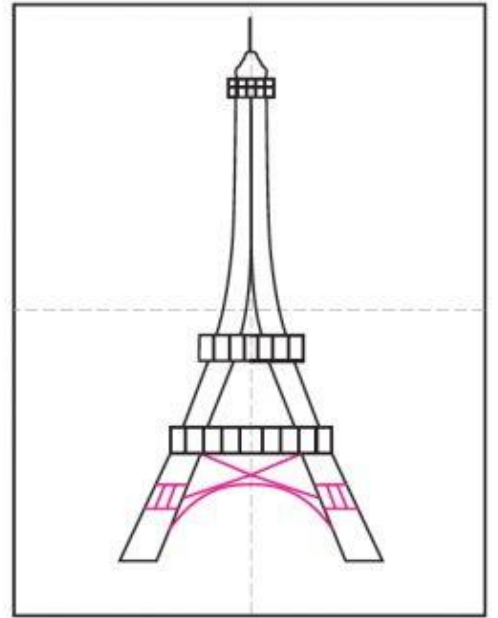
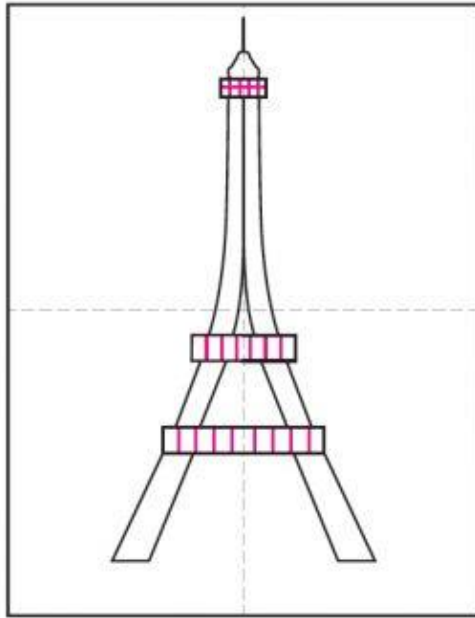
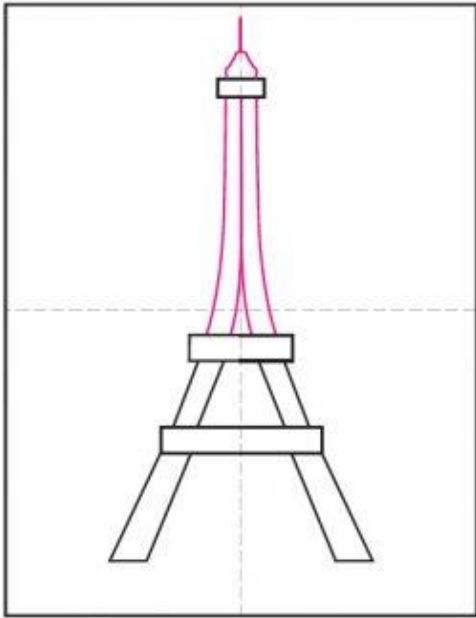
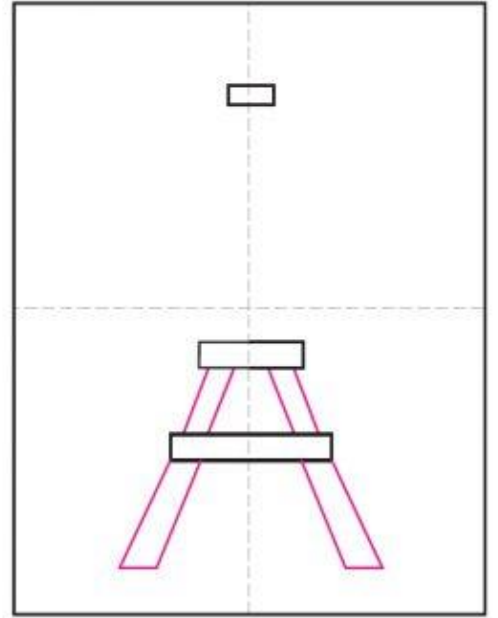
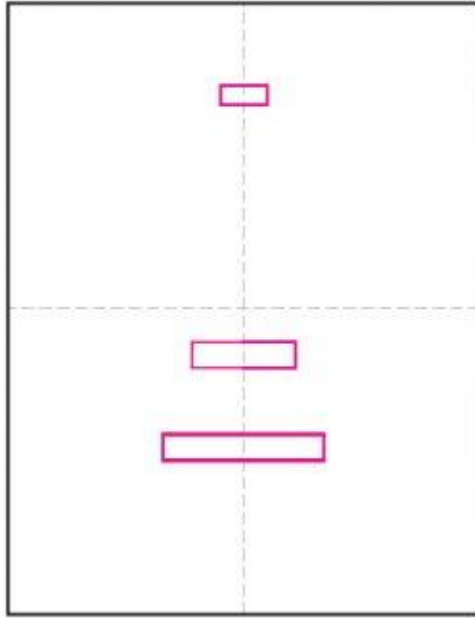
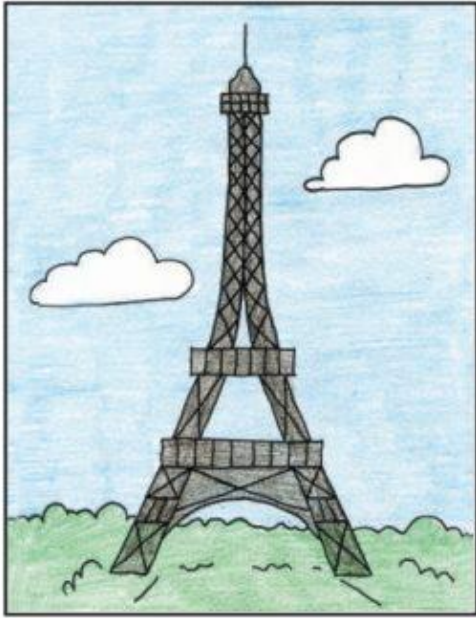



Supplies: Black marker, crayon.

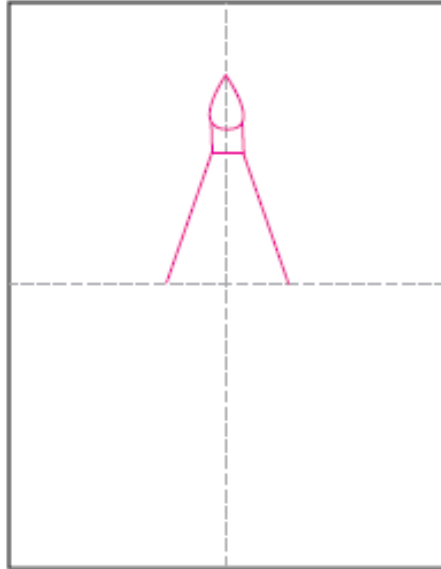

1. Start top of center building.

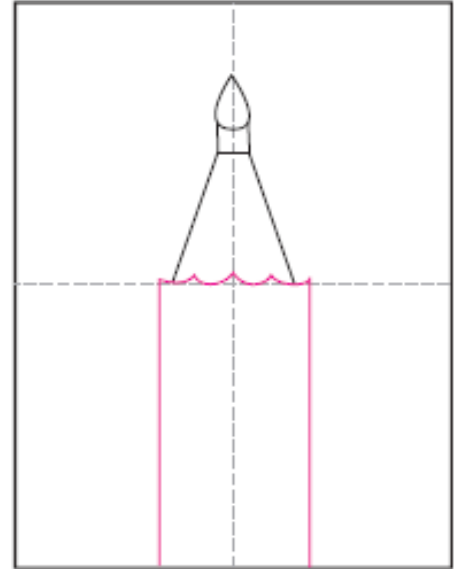

2. Draw bottom of center building.

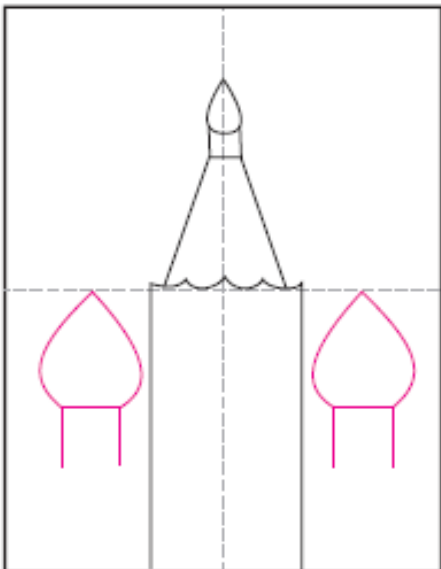

3. Start side tower tops.

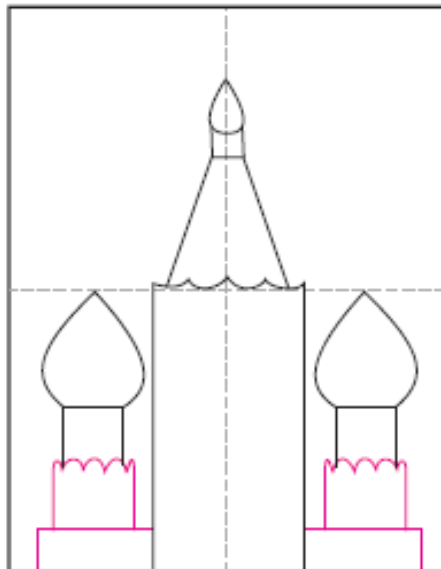

4. Finish side tower bottoms.

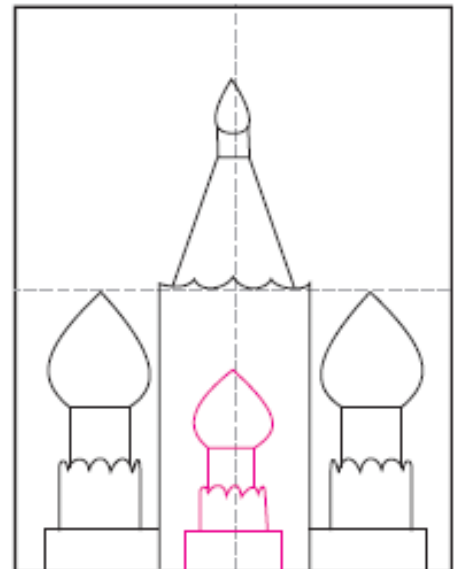

5. Draw small center tower.

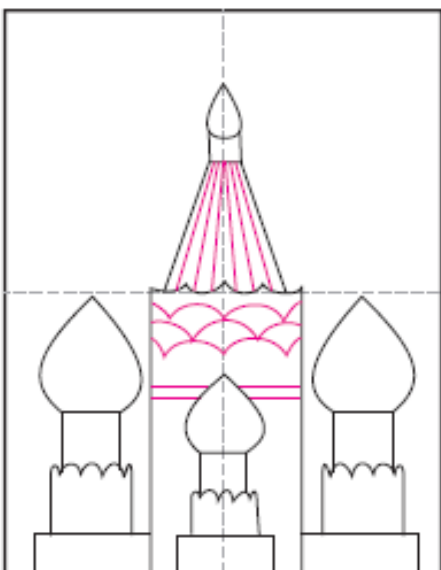

6. Add large center details.

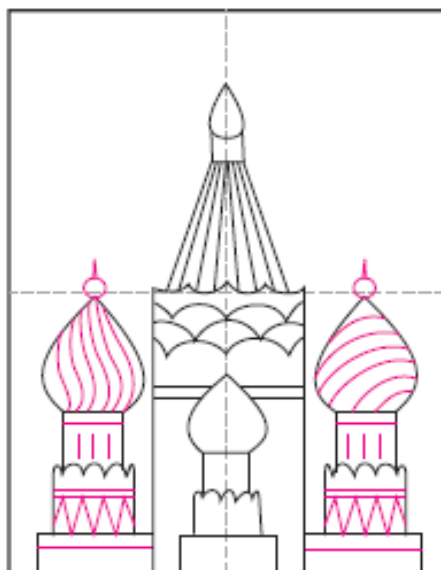

7. Add side tower details.

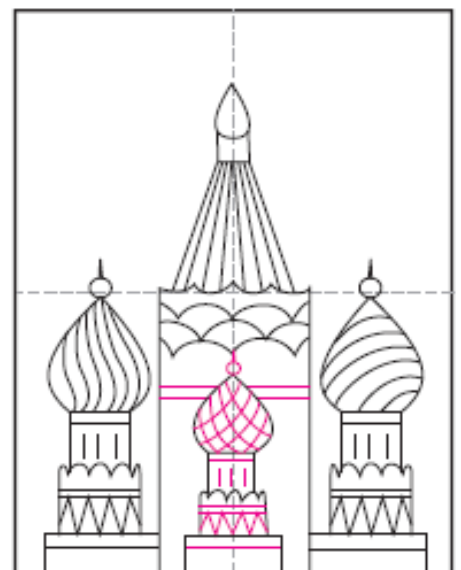

8. Finish center building details.

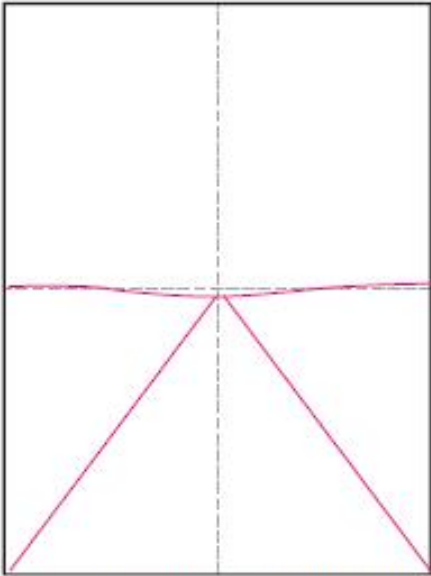

1. Draw the horizon line. Use a ruler to draw the boardwalk lines.

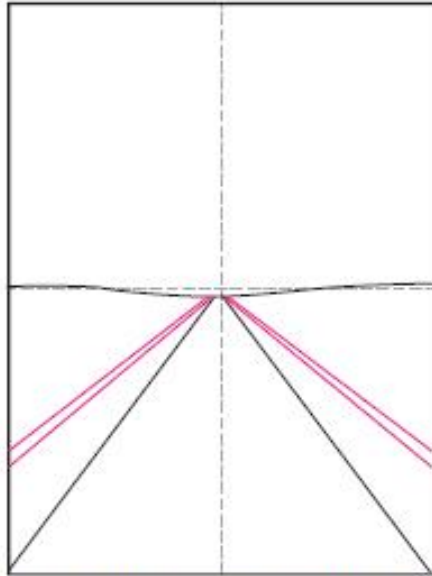

2. Use a ruler again to add more lines for the hand rails.

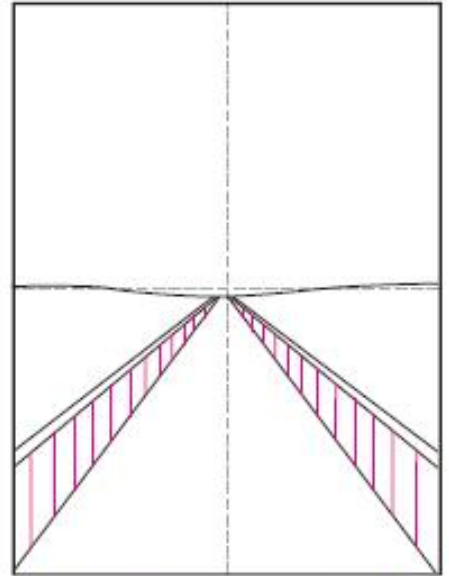

3. Draw vertical lines on the sides.

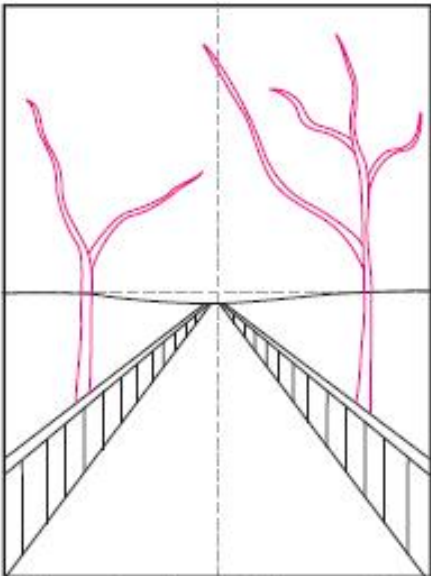

4. Draw two large tall trees with skinny wavy branches.

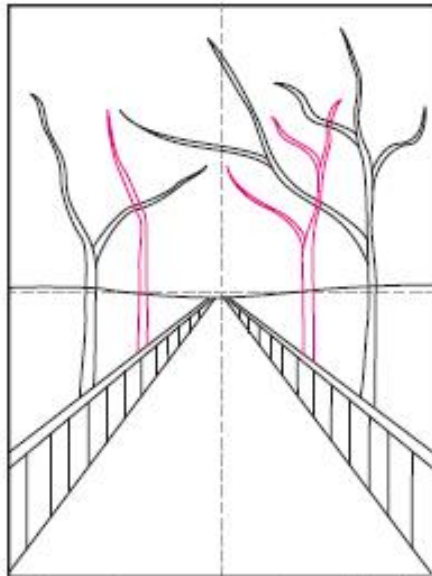

5. Draw two medium trees. It's fine if the branches overlap.

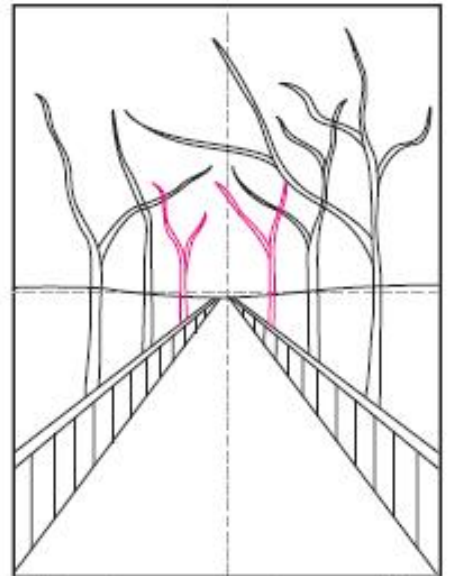

6. Draw two smaller trees, making sure they are the shortest.

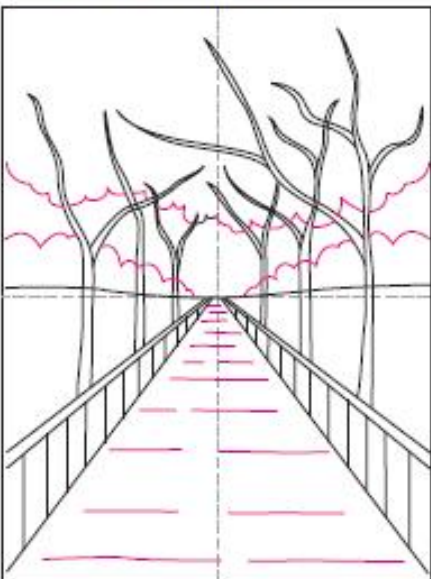

7. Add wavy lines for the trees and distant shrubs. Add board lines.



8. Trace with permanent black marker. Color random red splotches.



9. Fill the trees with orange. Make shadows with another layer of marker.

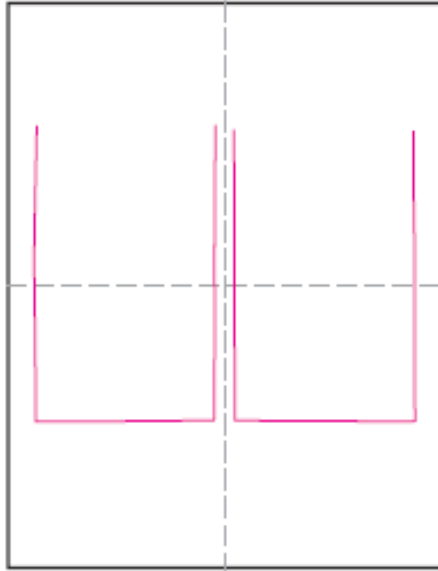

1. Make guide lines. Draw two U's.

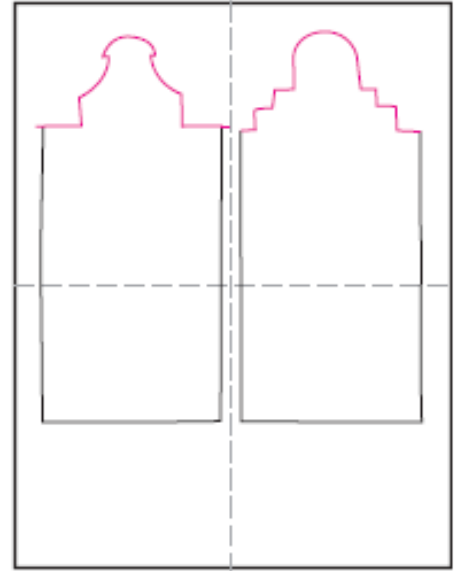

2. Add the rooftops.

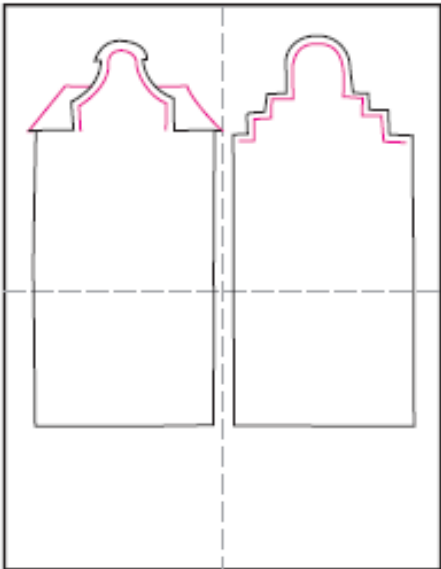

3. Finish the rooftops.

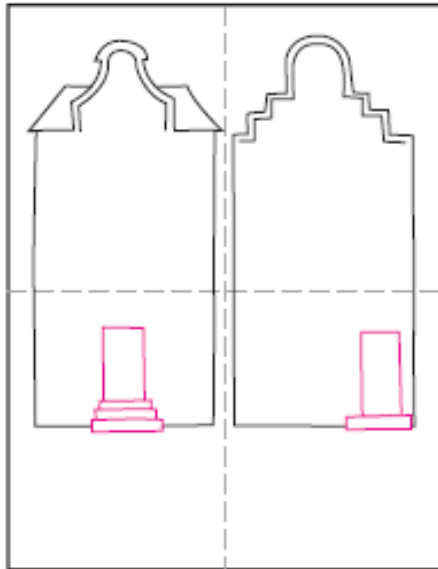

4. Draw two doors on steps.

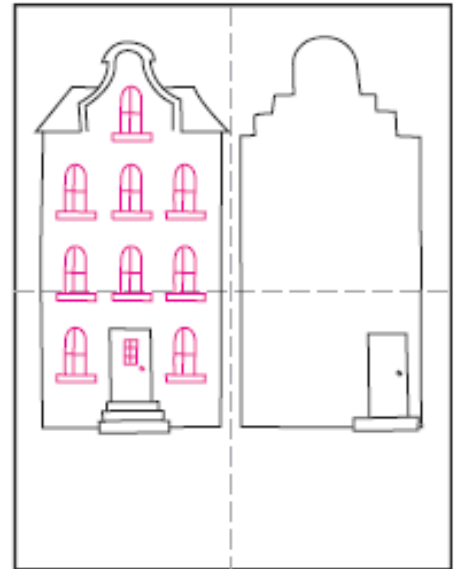

5. Draw rows of arched windows.

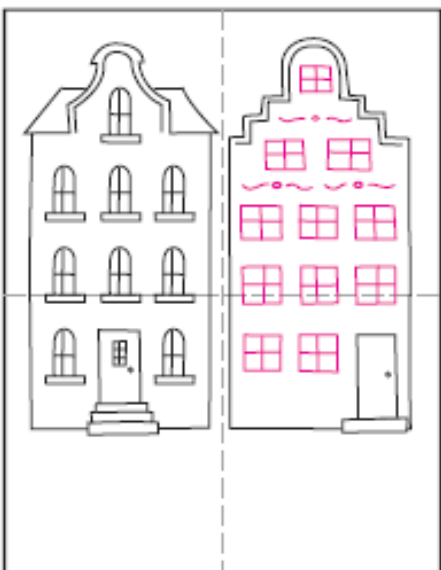

6. Add rows of square windows.



7. Draw the side wall and water.

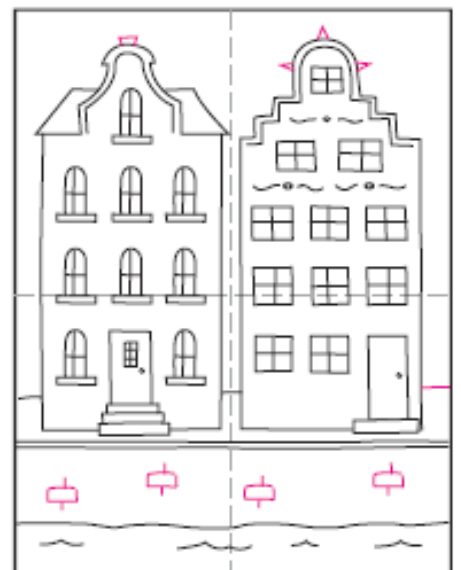

8. Add horizon lines and details.